

MS 900 Soap Dispenser Installation Instructions

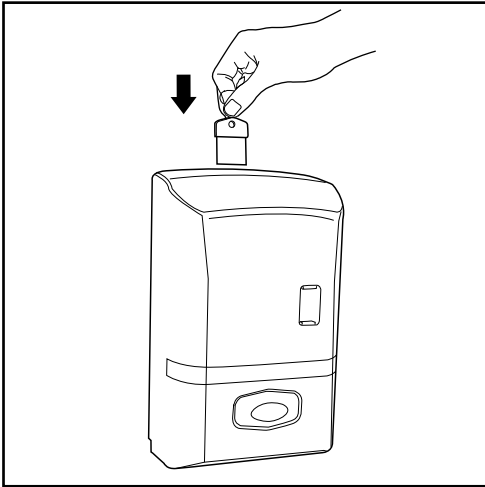

1 Insert key provided into keyhole and push until a 'click' sound is heard.

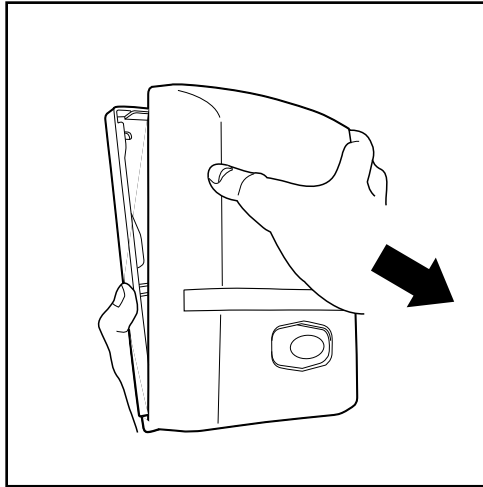

2 Pull out cover from base plate.

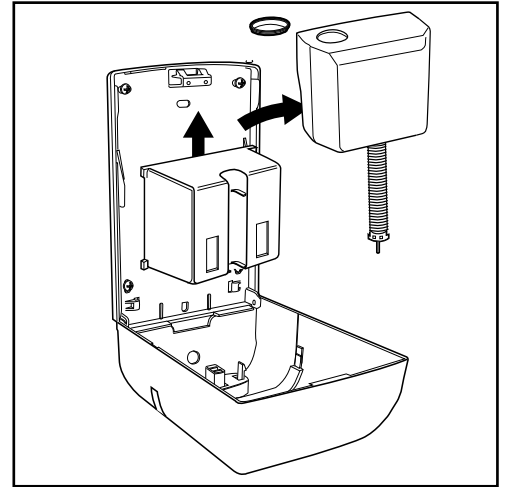

3 Remove lid. Take out container by sliding upwards and pulling outwards.

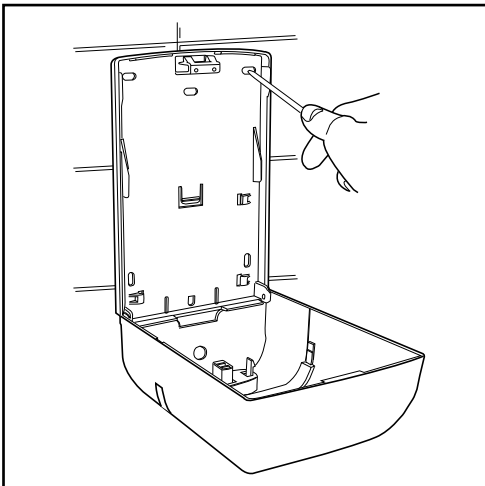

4 Mark position of holes on walls to be drilled.

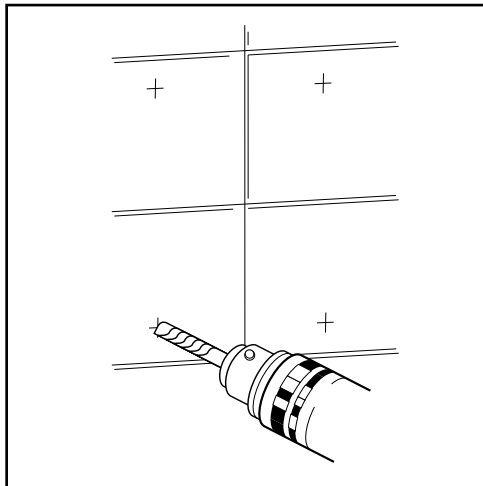

5 Drill $\frac{1}{4}$ " diameter holes with approximately $\frac{1}{4}$ " depth.

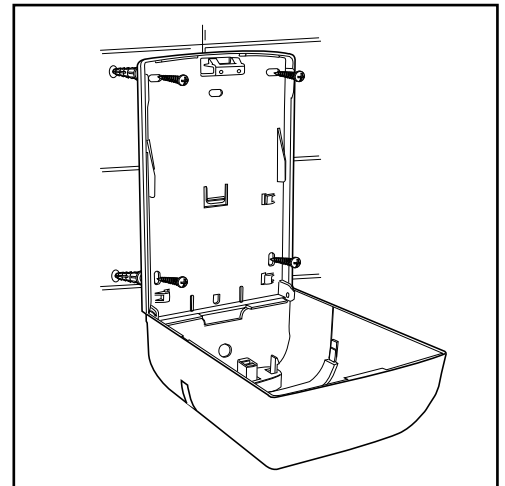

6 Insert plug provided and screw unit onto wall.

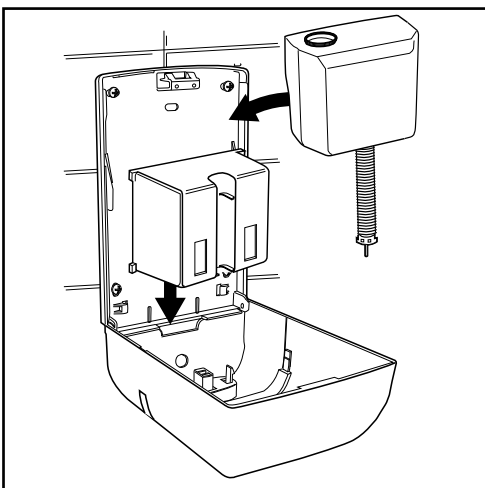

7 Replace container by pushing inwards and sliding downwards.

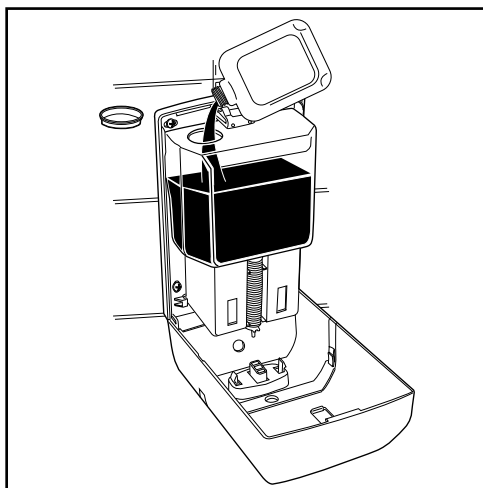

8 Pour liquid soap into container and close lid.

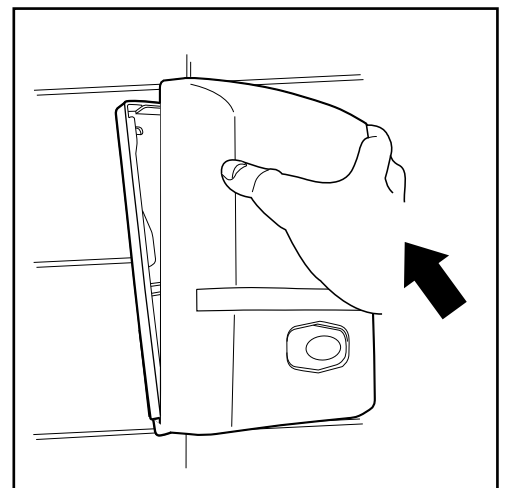

9 Replace cover by pushing inwards until a 'click' sound is heard.